

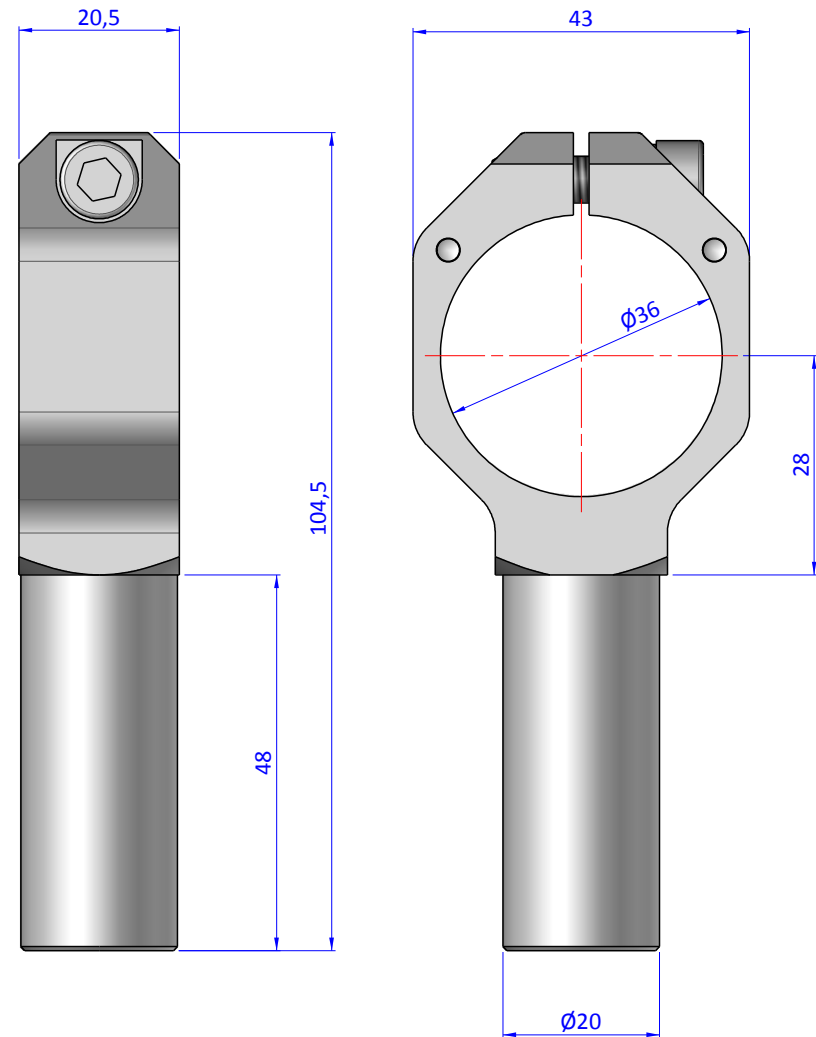

Item	Name	Q.ty
1	R.6.SCH	1
2	STF.36.01	1
3	V.TCE6x22	1

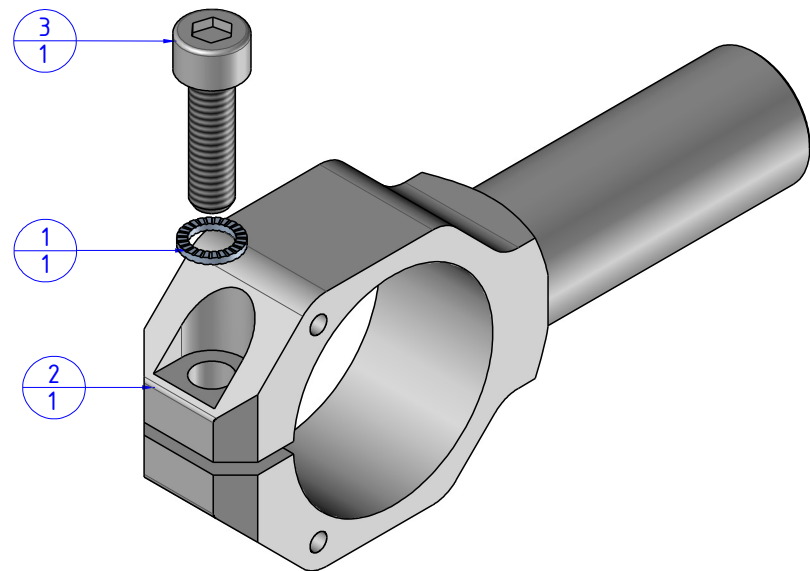

THE PROPERTY OF THE DRAWING IS ESTABLISHED BY LAW. IT IS FORBIDDEN TO PRODUCE OR SHOW IT TO THIRD PARTY, WITHOUT A WRITTEN AGREEMENT.

Format A3

UNI 936-76

 FPS FPSERVICES AUTOMATION		DESIGNED FROM		REVIEW
		FPS Automation		A
GENERAL TOLERANCE		DATE	WEIGHT	
UNI - ISO 2768		15/05/2019	0,088kg	
CLASSE f		CODE		
		CA.STF.36		CA.STF.36